

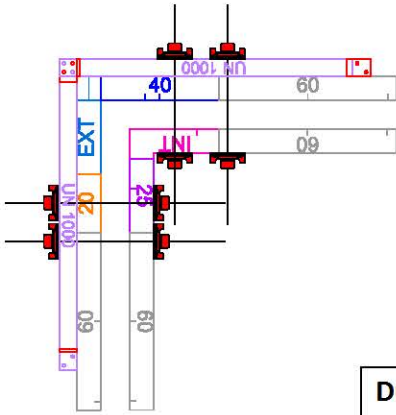

## KÖŞELER: Yukarıdan Görünüm

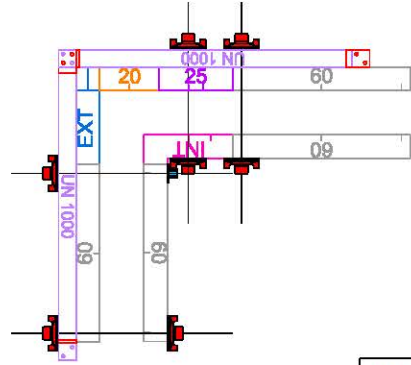

Duvar Kalınlığı  
10 cm



Duvar Kalınlığı  
15 cm

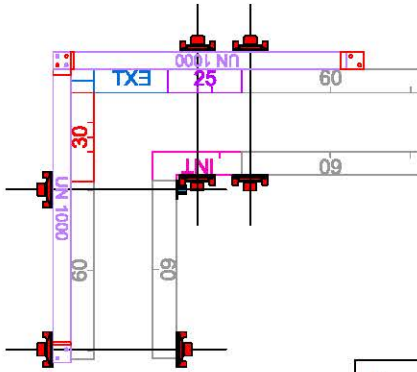

Duvar Kalınlığı  
20 cm

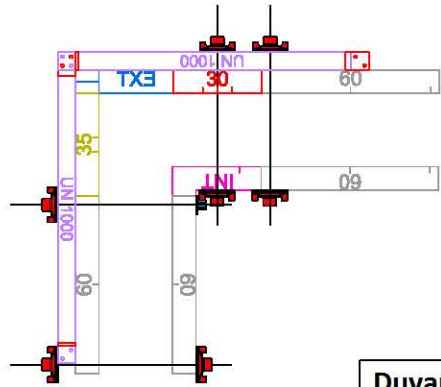

Duvar Kalınlığı  
25 cm

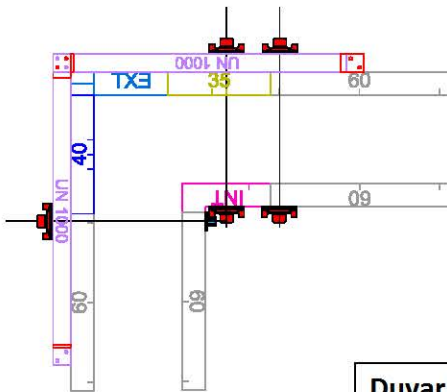

Duvar Kalınlığı  
30 cm

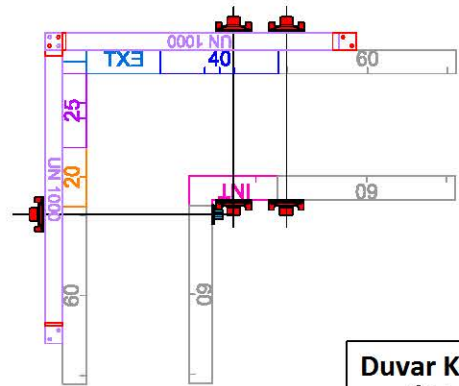

Duvar Kalınlığı  
35 cm

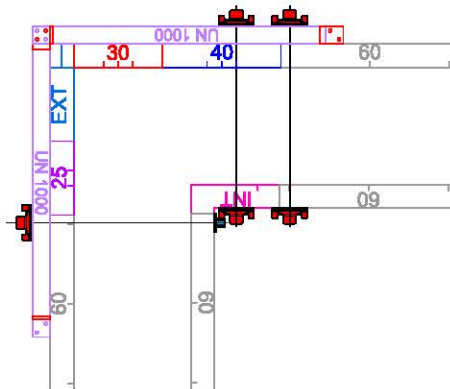

Duvar Kalınlığı  
40 cm

## KÖŞELER: Yandan Görünüm

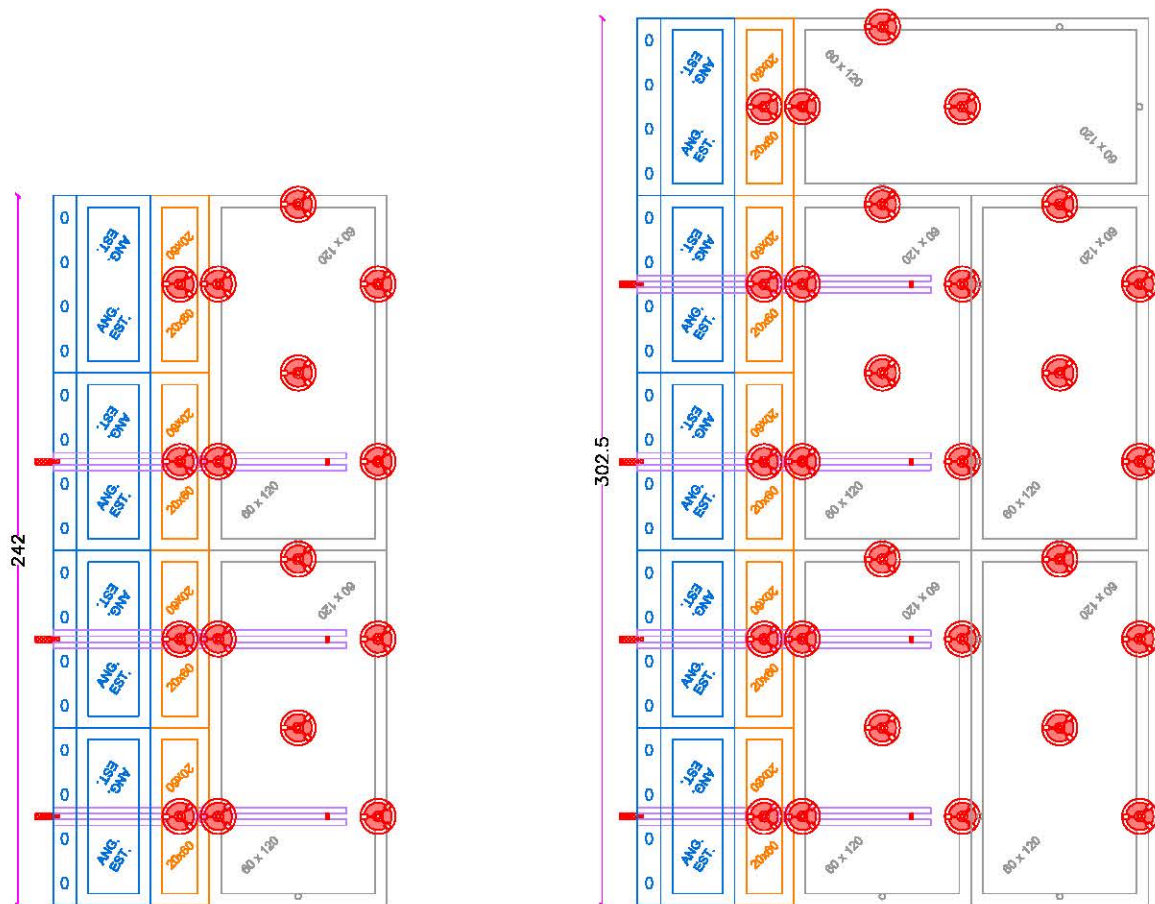
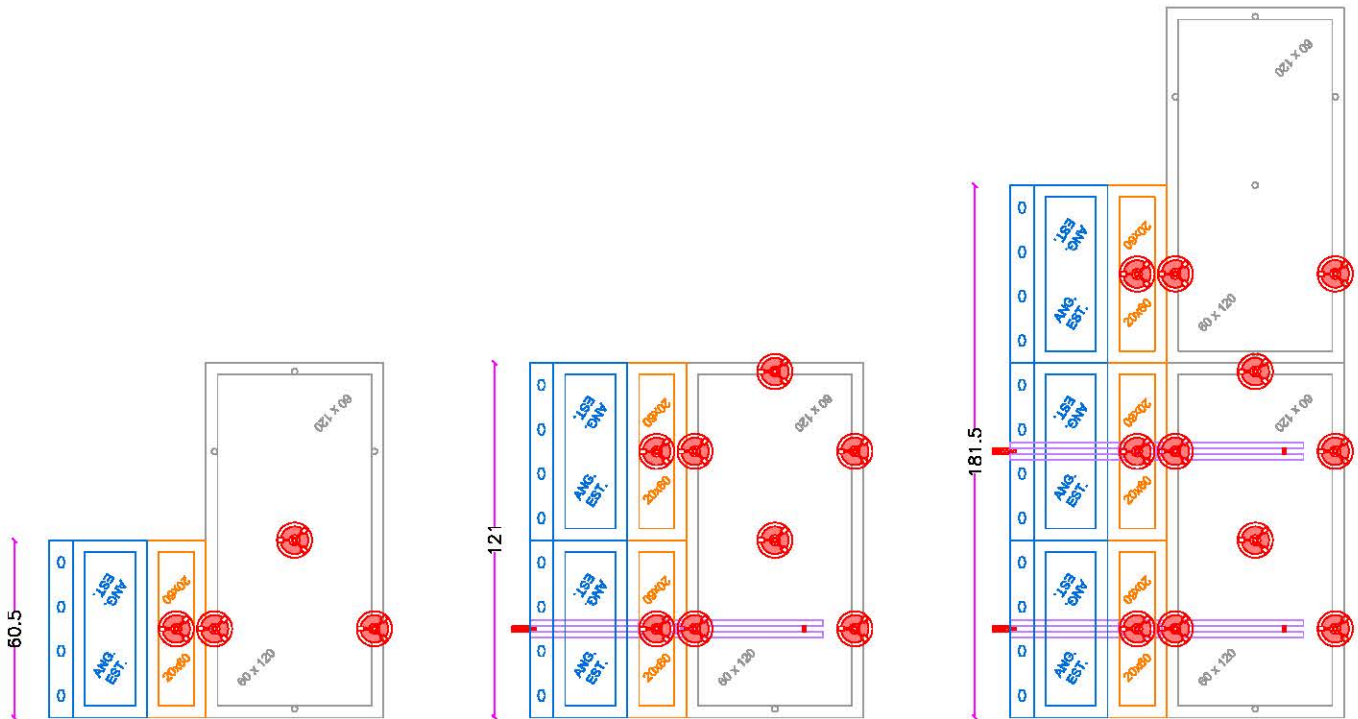



GEOPLAST S.p.A.  
Via Martiri della Libertà 6/8  
35010 Grantorto, Italy

www.geoplast.it

TECHNICAL DEPT.  
Date 20-01-2012

TECHNICAL COMMUNICATION  
no. 2012 - 01  
PAGE 3 of 8

## KÖŞELER: h = 3.00 m Duvarlar İçin Malzeme Listesi

KALIPLAR	DUVAR KALINLIĞI (cm)						
	10	15	20	25	30	35	40
GEOPANEL 20x60	5	5	--	--	--	5	--
GEOPANEL 25x60	5	5	5	--	--	5	5
GEOPANEL 30x60	--	--	5	5	--	--	5
GEOPANEL 35x60	--	--	--	5	5	--	--
GEOPANEL 40x60	5	--	--	--	5	5	5
İÇ KÖŞE	5	5	5	5	5	5	5
DIŞ KÖŞE	5	5	5	5	5	5	5
KOLLAR	130	100	100	105	110	130	130
<b>BAĞLANTILAR</b>							
SAPLAMALAR	10	5	5	5	5	5	5
SAPLAMA KORU.	0	5	5	5	5	5	5
KELEBEK SOMUN 120	20	5	5	5	5	5	5
KELEBEK SOMUN 65	--	5	5	5	5	5	5
<b>KUŞAK PROFİLLERİ</b>							
KUŞAK PROFİLİ	8	8	8	8	8	8	8
PIN Ø10	8	8	8	8	8	8	8

## "T" BİRLEŞİMLERİ: Yukarıdan Görünüm

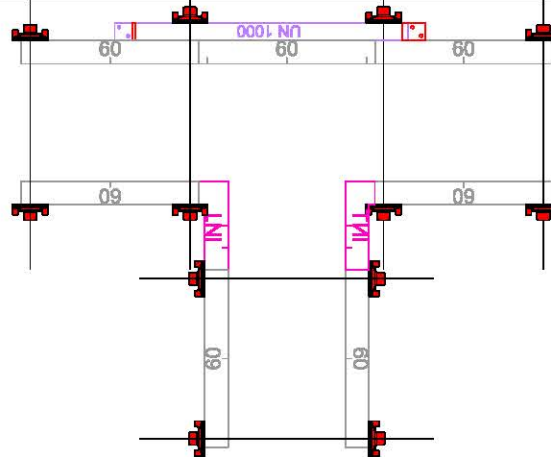
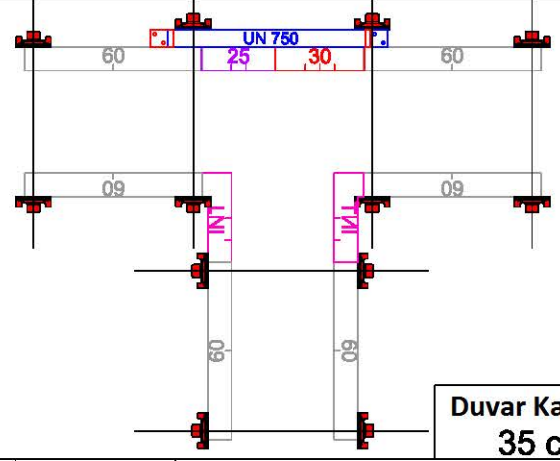
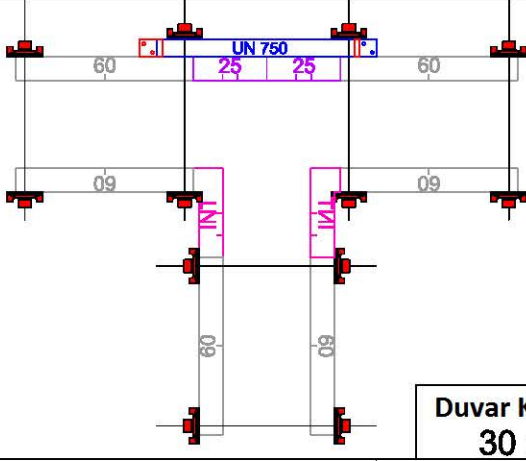
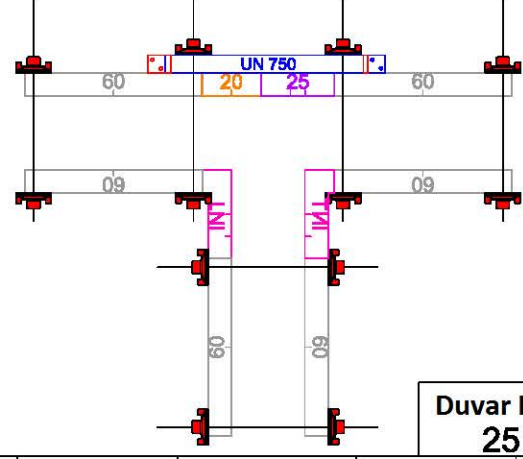
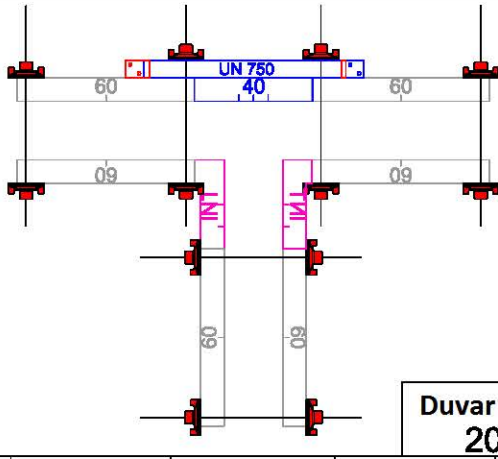
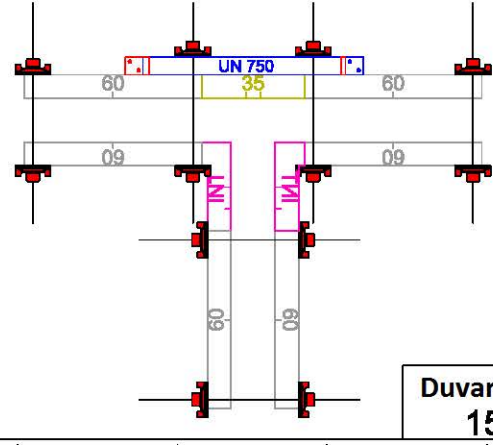
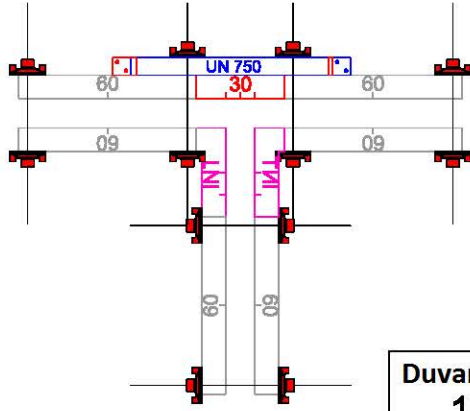



# "T" BİRLEŞİMLERİ Kalınlık 10-15-20 cm: Yandan Görünüm

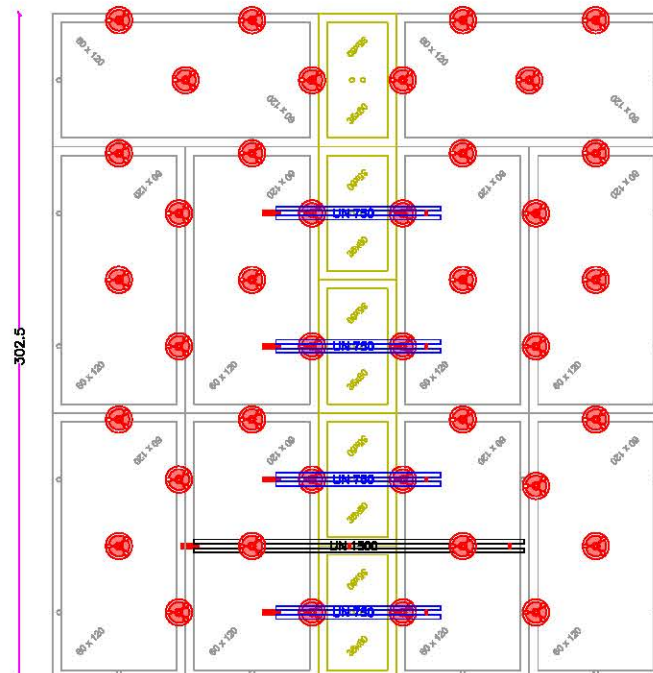
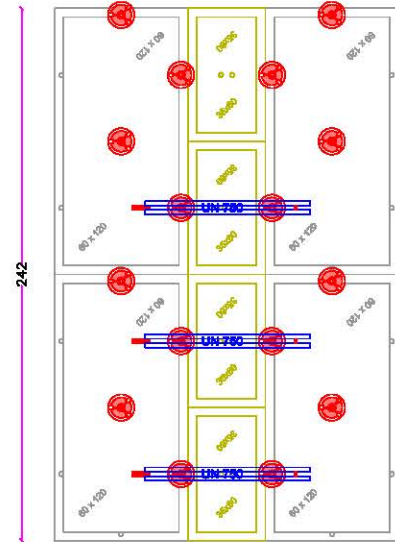
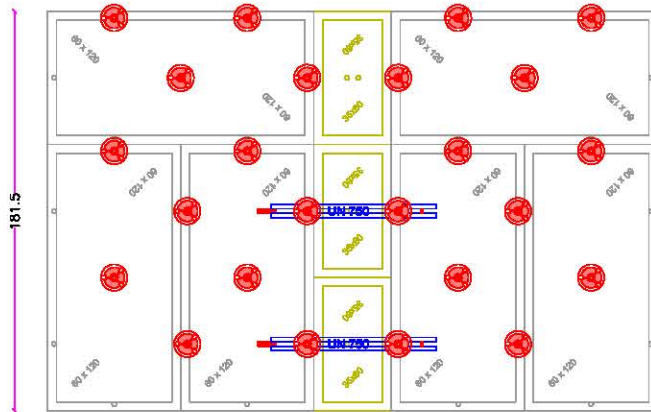
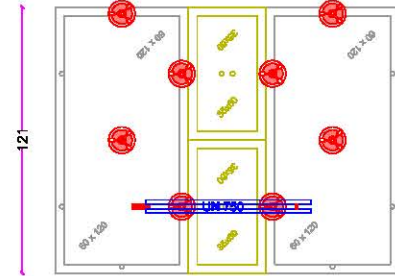
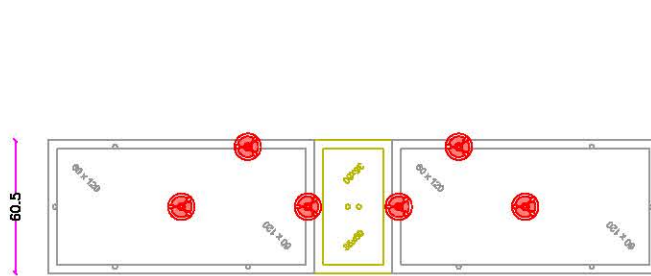





## "T" BİRLEŞİMLERİ Kalınlık 40 cm: Yandan Görünüm

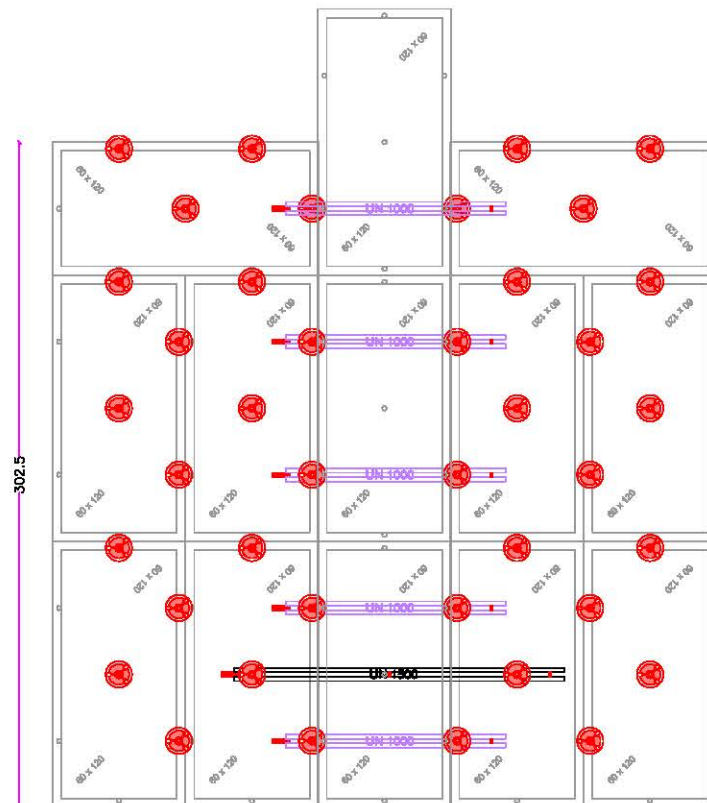
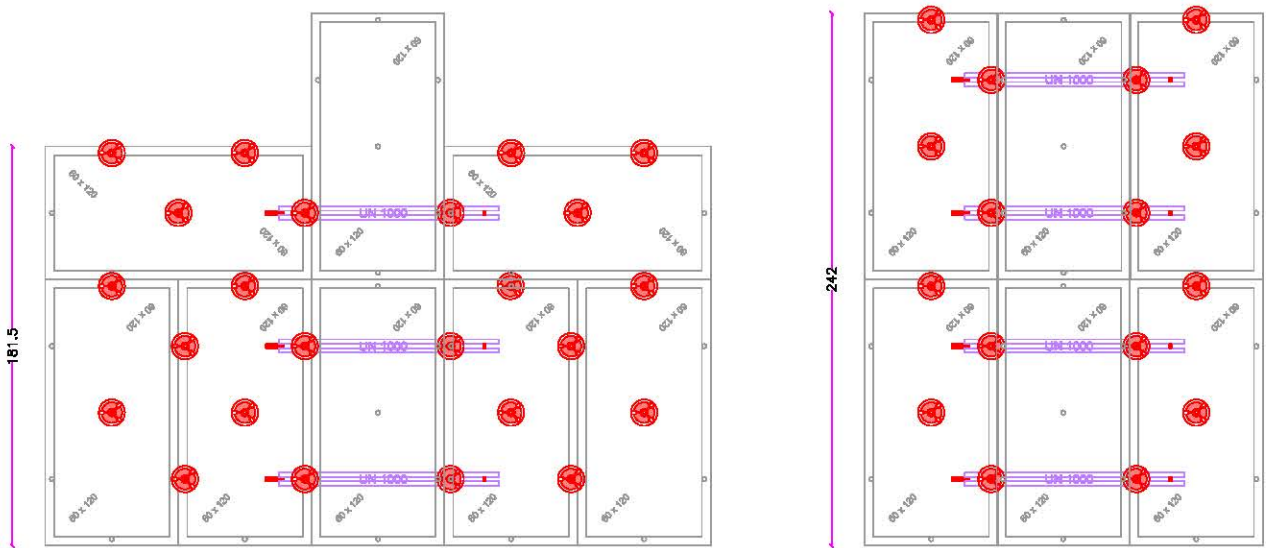
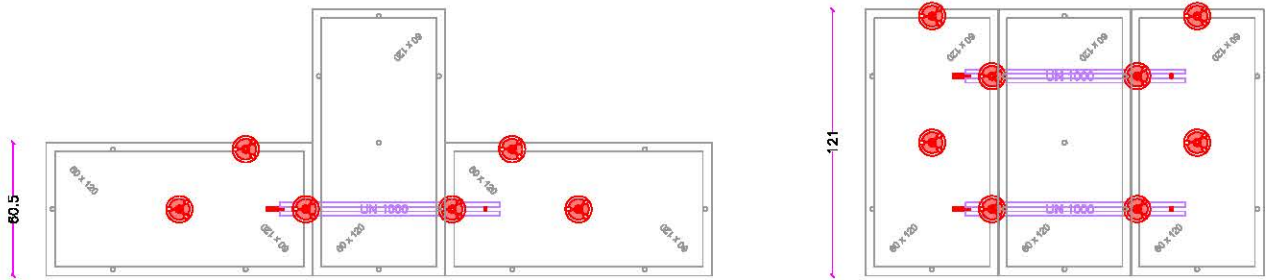



GEOPLAST S.p.A.  
Via Martiri della Libertà 6/8  
35010 Grantorto, Italy

www.geoplast.it

TECHNICAL DEPT.  
Date 20-01-2012

TECHNICAL COMMUNICATION  
no. 2012 - 01  
PAGE 8 of 8

## "T" BİRLEŞİMLERİ: h = 3.00 m Duvarlar İçin Malzeme Listesi

KALIPLAR	DUVAR KALINLIĞI (cm)						
	10	15	20	25	30	35	40
GEOANEL 20x60	--	--	--	5	--	--	--
GEOANEL 25x60	--	--	--	5	10	5	--
GEOANEL 30x60	5	--	--	--	--	--	--
GEOANEL 35x60	--	5	--	--	--	--	--
GEOANEL 40x60	--	--	5	--	--	--	--
GEOANEL 60x120	--	--	--	--	--	--	3
İÇ KÖŞE	10	10	10	10	10	10	10
KOLLAR	75	80	80	100	100	100	86

### KUŞAK PROFİLLERİ

KUŞAK PR. UN1500	1	1	1	1	1	1	1
KUŞAK PR. UN1000	--	--	--	--	--	--	5
KUŞAK PR. UN750	4	4	4	5	5	5	--